

CODIGO/CODE: 53873

**PRODUCTO: DUCHA NIAGARA SOLAR
PRODUCT: NIAGARA SOLAR SHOWER**

**MATERIAL/MATERIAL: AISI-304
ACABADO/ FINISH : PULIDO / POLISHED**

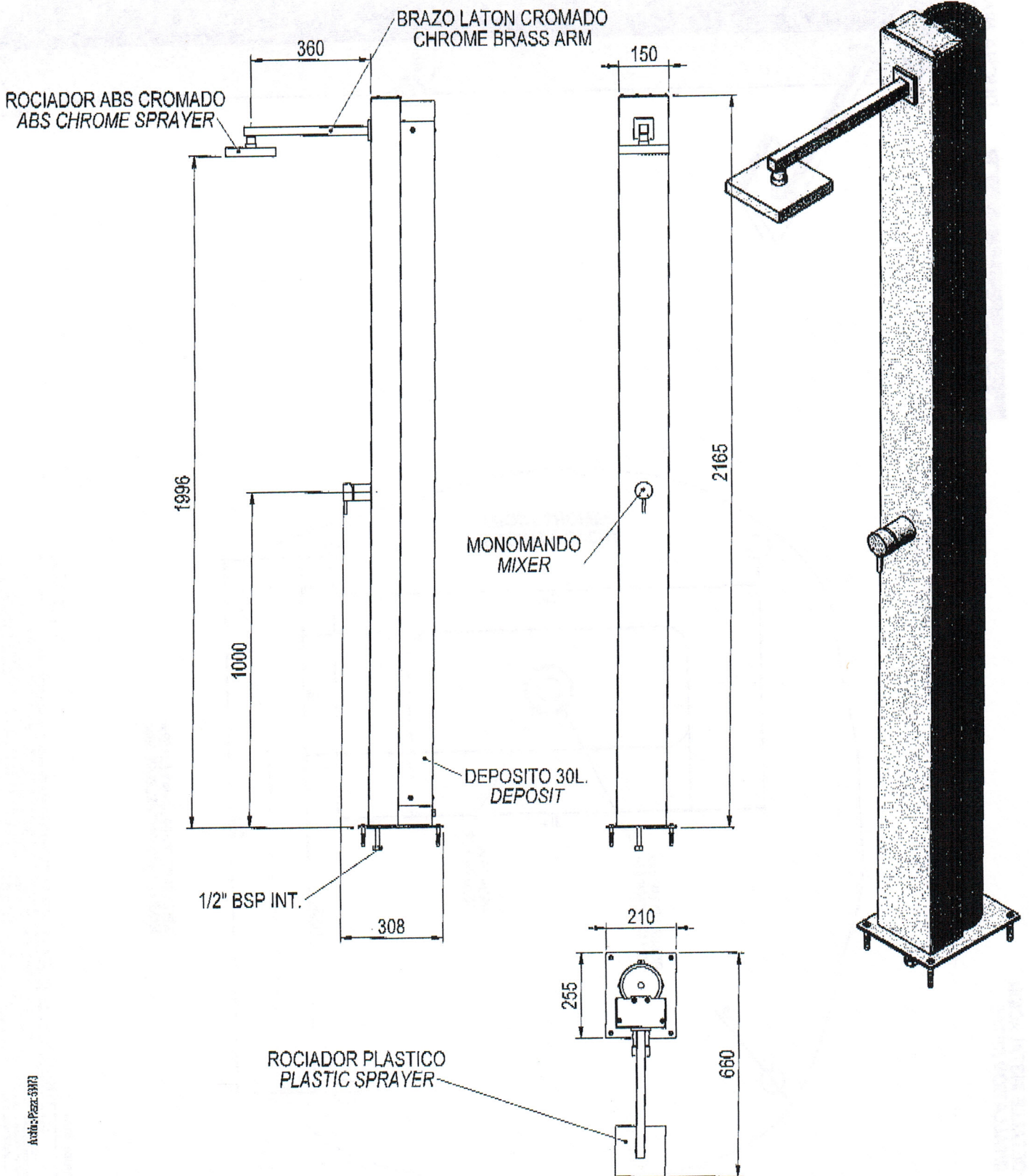

CODE 53873

BESCHREIBUNG: SOLARDUSCHE NIAGARA

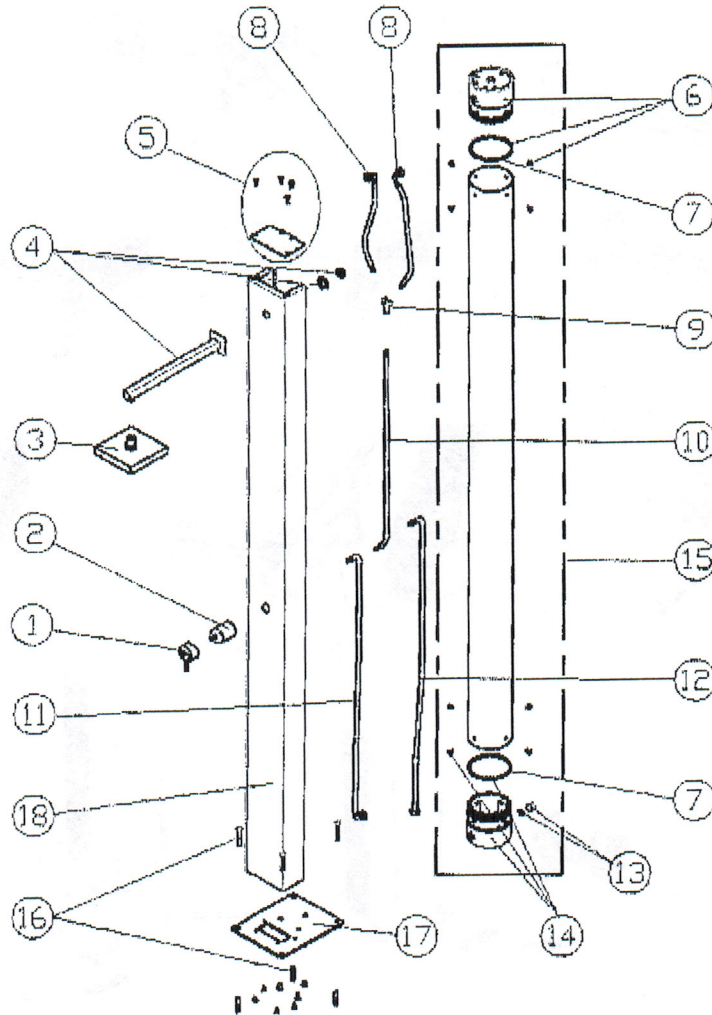

DEUTCHE

POS	CODE	BESCHREIBUNG	POS	CODE	BESCHREIBUNG
1	4401040070		10	4401043616	"FLEXIBLER SCHLAUCH 1/2" INNENGEWINDE + M-10 AUSSSENGE"
2	4401043505	EIN-HEBEL-GEHÄUSE	11	4401043617	"FLEXIBLER SCHLAUCH 1/2" ECK-INNENGEWINDE + M-10 AUSSSENGE"
3	4401040052	SPRENGER	12	4401043610	"FLEXIBLER SCHLAUCH 1/2" INNENGEWINDE + M-10 AUSSSENGE"
4	4401040053	DUSCHARM	13	4401049521	SET ABLASSPFROPFEN
5	4401040071	OBERER DECKEL	14	4401040073	
6	4401040072		15	4401040074	
7	4401043809	O-RING D. 100X6. 99	16	4401040068	SET FIXIERUNG
8	4401043514	"FLEXIBLER SCHLAUCH 1/2" INNENGEWINDE + M-10 AUSSSENGE"	17	53873R0110	
9	4401043615	"Y"-VERBINDUNG M-10 INNENGEWINDE"	18	53873R0120	

**COMPONENTES
COMPONENTS**

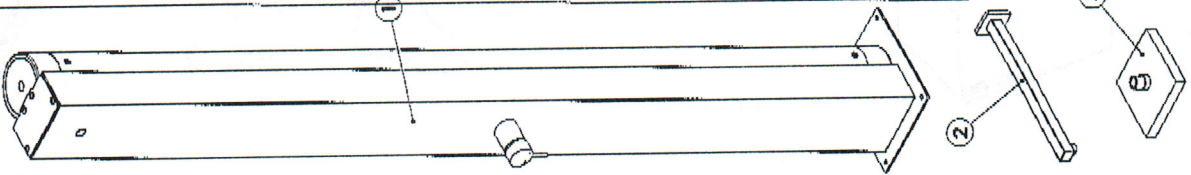

PASO 1 / STEP 1

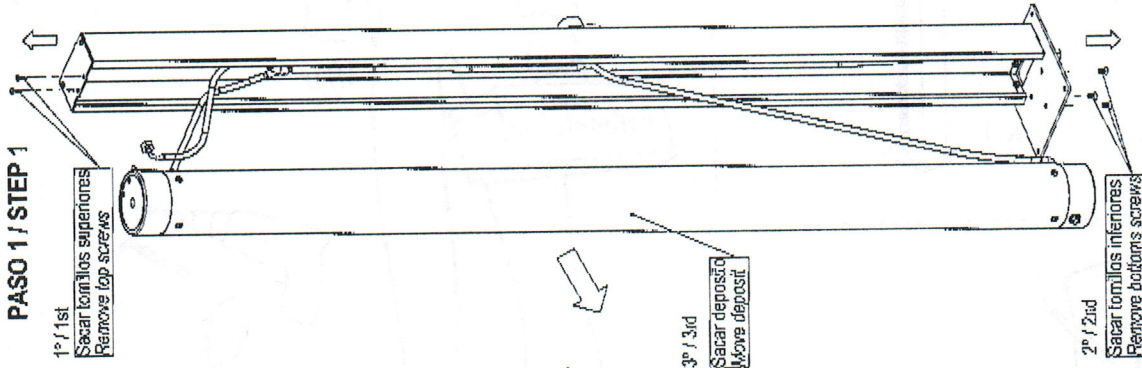

PASO 2 / STEP 2

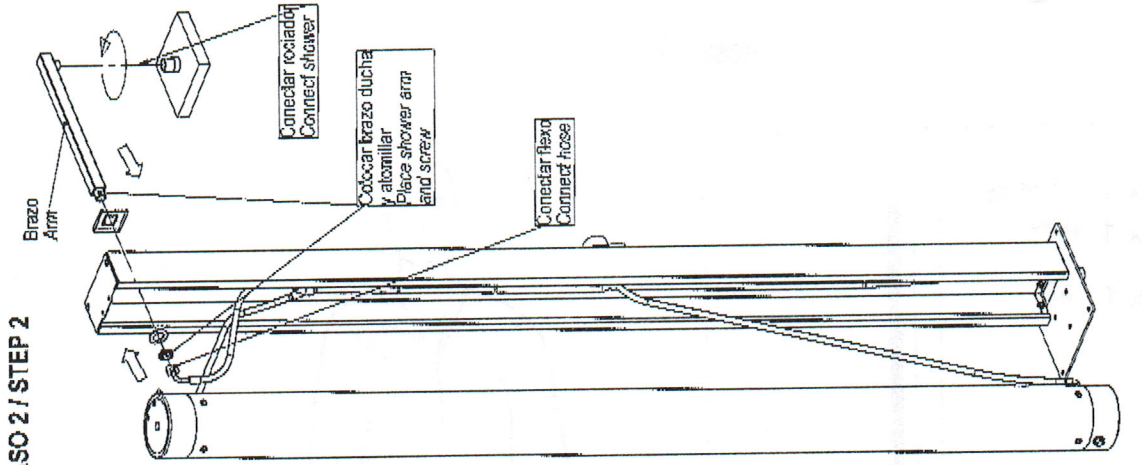

PASO 3 / STEP 3

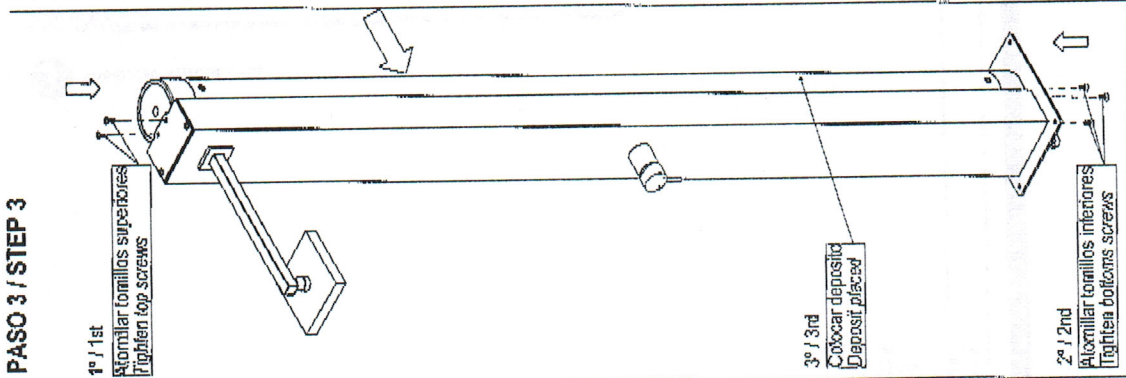

PASO 4 / STEP 4

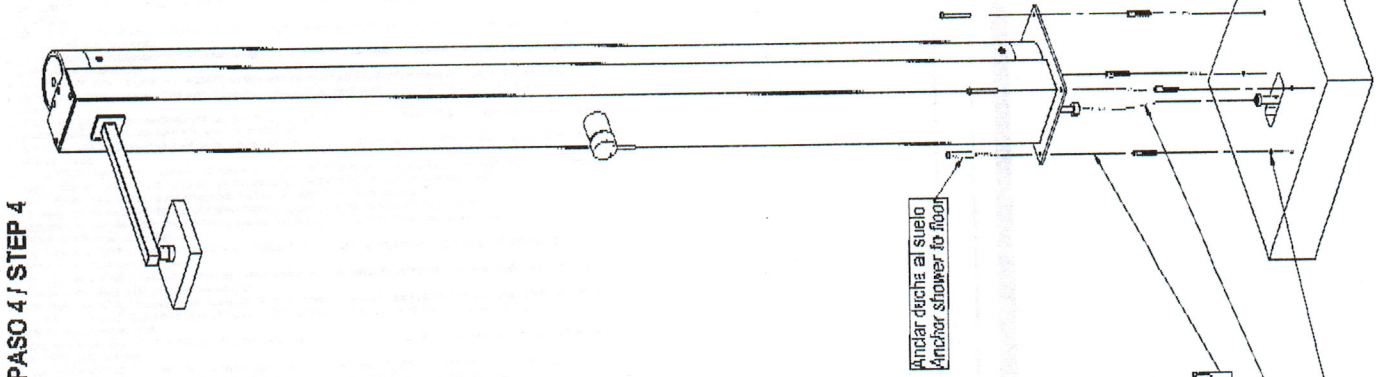

POS.	Descripción / Description	Cantidad / Quantity
1	Cuerpo ducha / Body shower	1
2	Brazo ducha / Shower arm	1
3	Rociador / Splinker	1
4	Bolsa tornillería / Screws bag	1

3

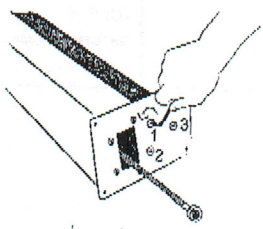

[6.1]

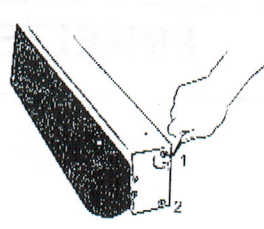

[6.2]

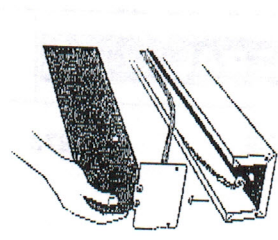

[6.3]

4

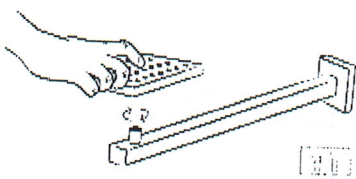

[6.4]

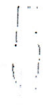

[6.5]

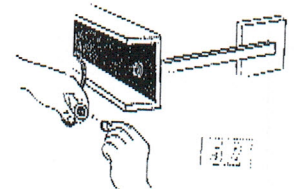

[6.6]

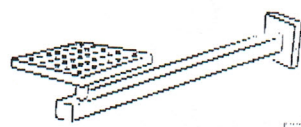

[6.7]

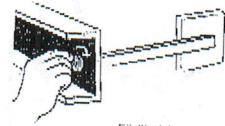

[6.8]

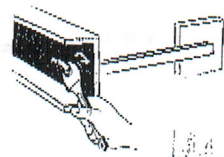

[6.9]

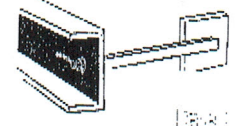

[6.10]

5

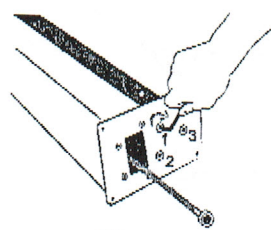

[6.11]

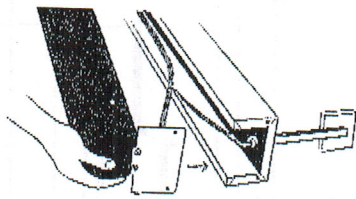

[6.12]

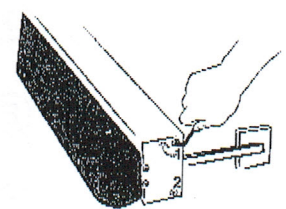

[6.13]

7

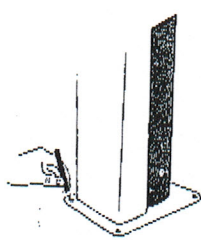

[7.1]



Ø 10mm



[7.2]

Press Max. 4 bar

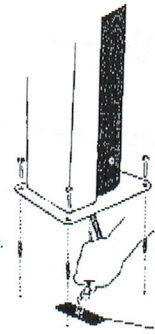

[7.3]

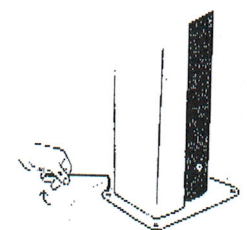

[7.4]

8

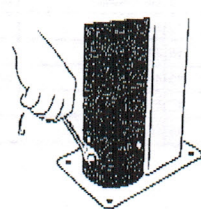
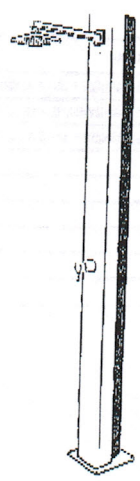

[8.1]

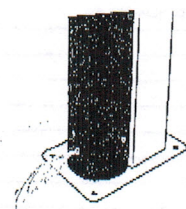

[8.2]

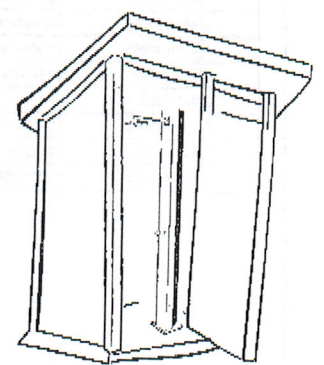

[8.3]

www.aquatec.com

1. Unpack the kit and check that all parts are present and undamaged.
 2. Read the instructions carefully before starting the installation.
 3. The kit is designed for use on a wall that is at least 2.5m high and 10cm thick.
 4. The kit is not intended for use on brick or stone walls.
 5. The kit is not intended for use on walls that are covered in wallpaper or other decorative finishes.
 6. The kit is not intended for use on walls that are made of concrete or masonry.
 7. The kit is not intended for use on walls that are made of wood or other soft materials.
 8. The kit is not intended for use on walls that are made of metal.
 9. The kit is not intended for use on walls that are made of glass or other brittle materials.
 10. The kit is not intended for use on walls that are made of any material that is not listed in the instructions.
 11. The kit is not intended for use on walls that are made of any material that is not listed in the instructions.

www.aquatec.com

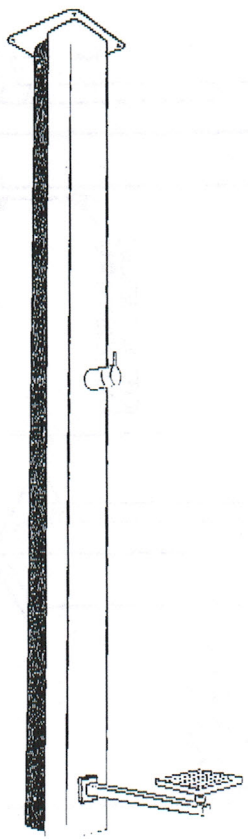

53873

53873 53873-02

